

Race Mount

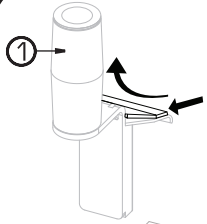

Required Tools:
5mm Allen wrench

Contents:

#	QTY	Name
1	1	Race Hub
2	1	Arm
3	1	Adapter Plate
4	4	Adapter Plate Screw
4	4	Monitor Screw

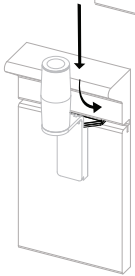
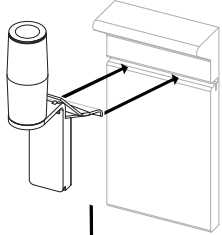

Adjusting Counter Balance

*Required Tool: 5mm Allen Wrench

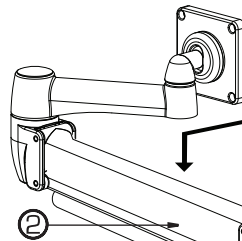

Position Arm so it is parallel to desk surface.

Turn bolt clock wise for Lighter monitors.

Turn bolt counter clockwise heavier monitors.

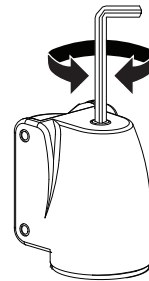

Instructions

Adapter Plate

Standard Arm Mount: 75mm
Adapter Plate: 100mm
*Attach adapter Plate to arm if needed.
*Lay Monitor face down and attach SpaceArm to Monitor.
*Place SpaceArm and monitor into hub and adjust counter balance.

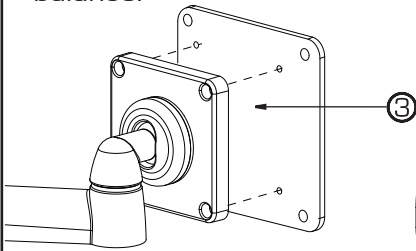

Cable Routing

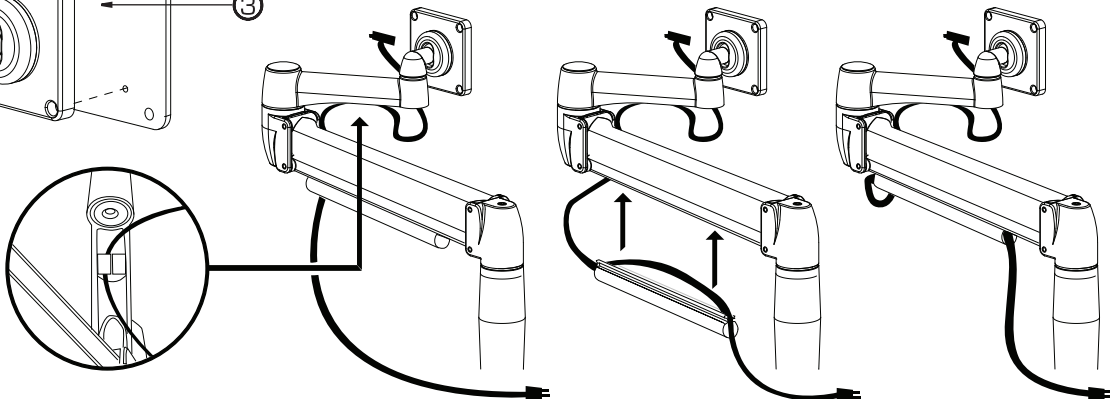

SpaceCo, Inc.
800.840.8499
www.spaceco.com